

Sanitary fixing systems

Installation instruction

. A6003-

. WC, BIDET&SEMI-PED FIXING SET

. Usage

For fixing of:standing toilets and bidets.

. contents

1	2×Floor brackets
2	2×wallplugs S10×50
3	2×Hex head screw 6×60
4	2×Washers
5	2×St. Steel Screw 5×60
6	2×Nylon Bushes
7	2×Chrome Caps

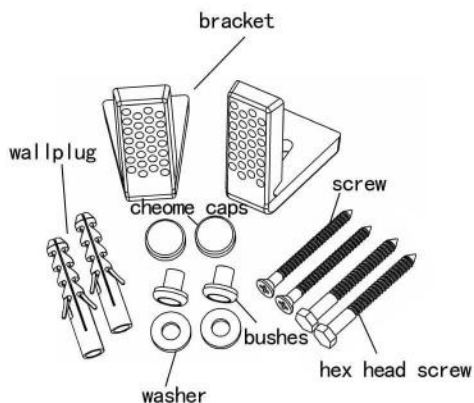

Toiler, bidet

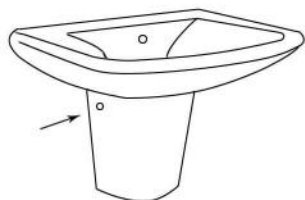

semi pedestal

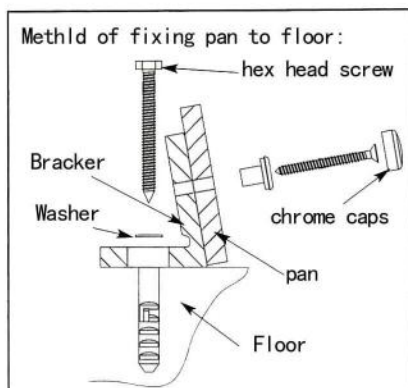

Dual Flush Valve Instruction

Installation Layout

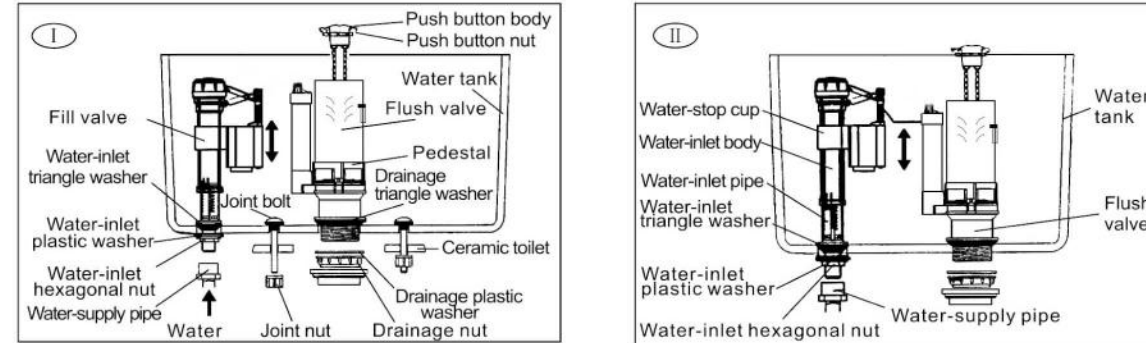

- Tip**
1. Read all manipulation and installation guideline, and please install it step by step according to the installation guideline and prevent any damage from product breakage and improper use.
 2. All material are written according to the latest information when design. Our company reserve the right to change product characterizes, package and supply at any time without notice.
 3. Do not use corrosive detergent (such as hypochlorite) in water tank because such strong oxidant makes fittings damaged easily and lead to leakage. The mentioned above situations are beyond the range of our guarantee.
 4. Our company do not bear the related loses and damages caused by use other company's parts and material such as glass glue.
 5. Suitable temperature range: 0~45°C

Functional Instruction

1. The flush valve has 2 flushing ways: half-flush and full flush; when you push the full flush, the discharge volume is big and when you push the half flush, the discharge volume is small.
2. Water level of half flush is adjustable. (Refer to photo 2)
3. Water level of full flush is adjustable. (Refer to photo 3-2)

Installation Steps

I. Preparation before Installation

Remove the old fittings and wash tank before installation. And wash clean because many impurities probably existed in conduit.

II. Flush Valve Installation (According to the actual need)

1. Stainless steel hook for one-piece flush valve installation

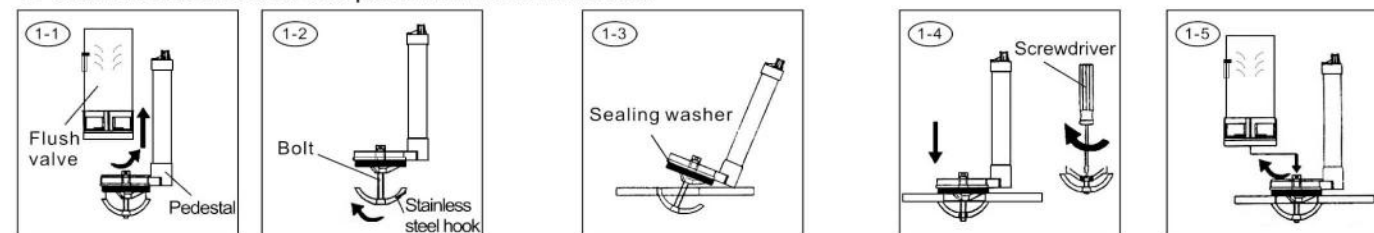

Contrarotate drainage body and make it removed from pedestal.

Circumrotate stainless steel hook to the end of bolt clockwise.

Let pedestal aim at the water tank scupper, deflect properly, circumrotate, and, the stainless steel hook can reach the scupper downside, then, revise the pedestal, the sealing washer should put upside. Go through the pedestal by the middle finger of left hand to keep off stainless steel hook and make its both sides put around the outfall symmetrically.

Circumrotate bolt by screwdriver and be sure that seal between sealing washer and the surrounding for outfall.

Let flush valve body insert into pedestal and circumrotate it inside the buckle clockwise.

2. Two-piece flush valve installation

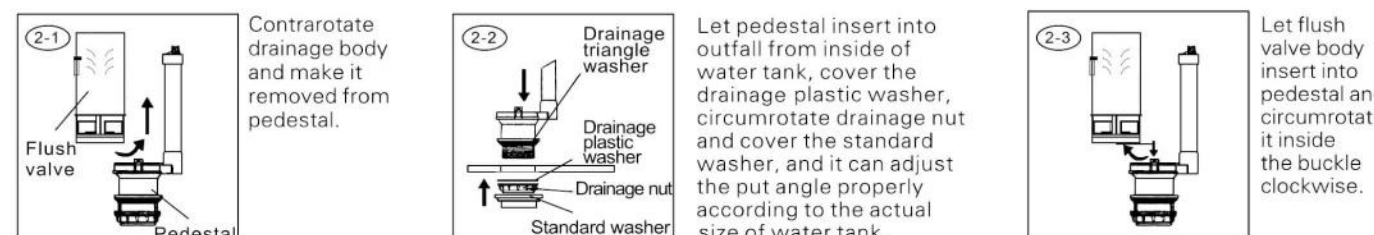

Contrarotate drainage body and make it removed from pedestal.

Let pedestal insert into outfall from inside of water tank, cover the drainage plastic washer, circumrotate drainage nut and cover the standard washer, and it can adjust the put angle properly according to the actual size of water tank.

Let flush valve body insert into pedestal and circumrotate it inside the buckle clockwise.

Notice: If the product is different from the photo shown, please refer to the actual product.

III. Fill Valve Installation

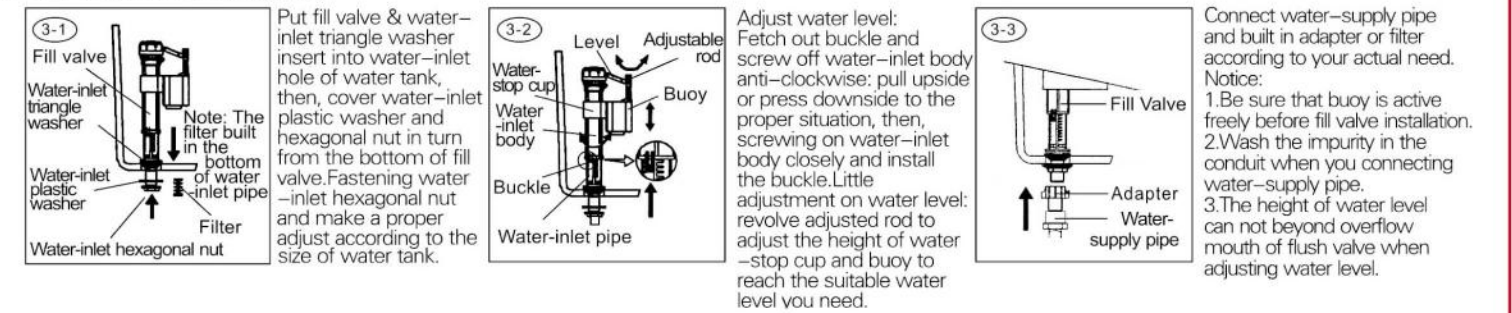

V. Water tank Installation

Put water tank on ceramic toilet and make standard washer located at the outfall of toilet. Just the photo shows, let jointed bolt insert into installation hole, then, screw the jointed nut closely.

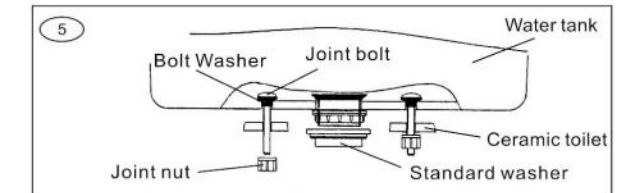

VI. Examination

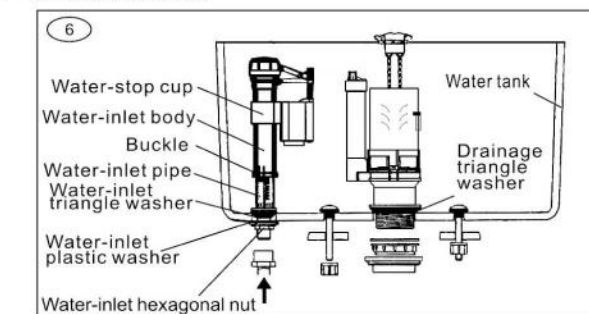

As photo show, connect water-inlet pipe to test and notice the following phenomenon:

1. According to the height of half flush to adjust half flush water level: when half flush buoy is higher, the drainage volume is less; when it is lower, the drainage volume is more.
2. Adjust the height of water level by the adjusted digit and its corresponding adjusted patch. The placket is big and its water level is high; the placket is small and its water level is low (Note: When adjusting full flush water level, please fetch out flush valve, then, install flush valve again correctly after adjusted.)
3. Adjust all parts position to prevent them from interference.
4. Open & close for water-stop cup is normal and has no leakage.
5. It is normal for full flush and half flush.

VII. Push button Installation

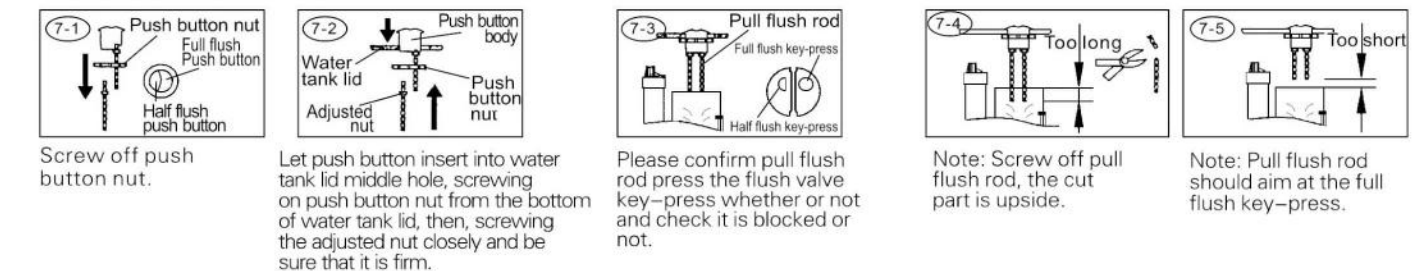

VIII. Examination Again

Cover water tank lid and notice the following phenomenon to confirm installation complete or not:
1. Open & close for water-stop washer is normal and has no leakage.
2. It is normal for full flush and half flush and they flush excellently.

Trouble Shooting

Symptoms	Probable Reasons	Corrective actions
Water level is too high or too low	Do not adjust the water level of fill valve well	Refer to photo 5 to adjust water level
Always water-inlet or do not water-inlet (for fill valve)	1. Switch of fill valve is close 2. Buoy is extrusive by water tank wall. 3. Filter has been blocked owing to bad water quality	1. Open the fill valve switch. 2. Adjust fill valve direction. 3. Wash filter (refer to photo 3-1).
Leakage	1. Fill valve nut is loose. 2. Flush valve does not installed well. 3. Pull flush rod is too long to cling outfall well (refer to photo 7-4). 4. Flush valve body and pedestal does not match well. 5. Refill water pipe insert into overflow mouth too deep.	1. Screw the fill valve nut closely. 2. Install flush valve again according to its installation step. 3. A. Adjust the adjusted nut (refer to photo 7-2, 3, 4); B. Shorten the pull flush rod. A is prior to B. 4. Install again (refer to the installation of flush valve). 5. Refill water pipe depth can not beyond the height of water level.
No drainage or less drainage	Pull flush rod is too short to press drainage pipe	Adjust adjusted nut (refer to 7-2).
Water level for half flush is too high or too low	Water level does not adjusted well	Adjust water level (refer to photo 6).

Soft Close Toilet Seat Installation Instructions

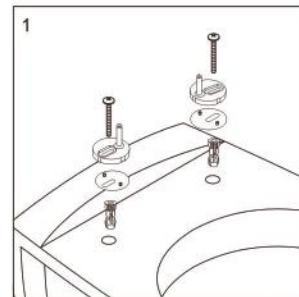

Insert the hinges into the toilet.

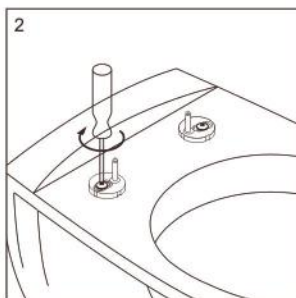

Tighten the screws in a clockwise direction (do not over tighten)

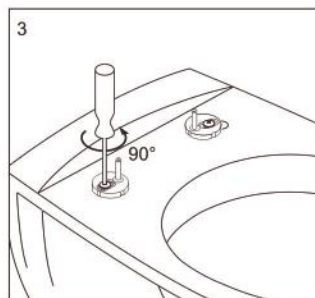

Untighten the screws a bit by turning them 90° in a anti-clockwise direction this will allow you to align the seat.

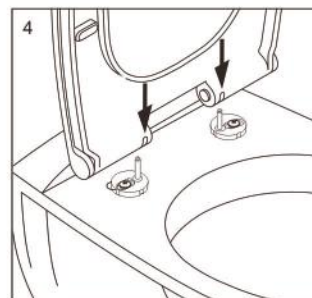

Clip on the toilet seat.

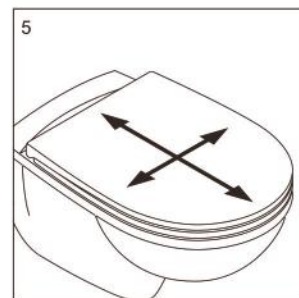

Align the toilet seat with ceramic bowl.

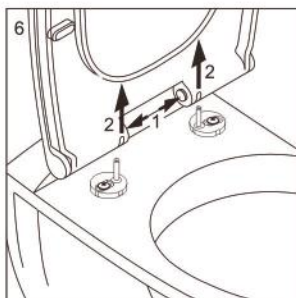

Take off the toilet seat by pressing both push buttons.

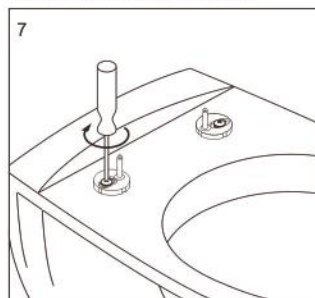

Tighten the screws in a clockwise direction

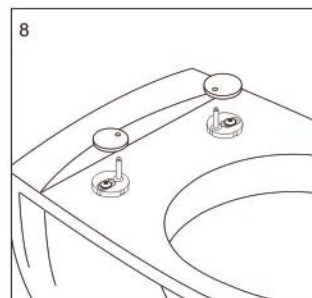

Place the cover over the hinges

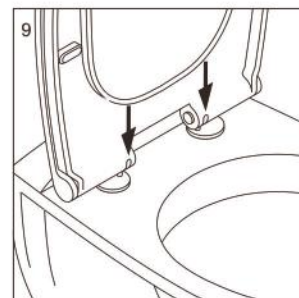

Clip on the toilet seat and cover.